



## **REYNOLDS NUMBER SCALING OF AXIAL FLOW FANS**

Gerhardus STEENKAMP, Chris MEYER, Johan VAN DER SPUY

*Stellenbosch University, Department of Mechanical and Mechatronic  
Engineering, Joubert Street, Stellenbosch, 7600, South Africa*

### **SUMMARY**

It is assumed that increasing the turbulence intensity of the flow in which an axial flow fan is tested is similar to increasing the Reynolds number at which the fan operates. Using three passive mesh grids for turbulence production and a modified ISO 5801 fan test facility, this assumption is investigated. Experimental testing of the M-fan at a sufficiently high blade setting angle validates this claim. Testing of the M-fan under design conditions further indicate that it operates independently from turbulence intensity and Reynolds number effects.

### **INTRODUCTION**

Large scale axial flow fans are an important component in the efficient operation of air-cooled condensers (ACC), such as those used in dry-cooled power plants. The efficiency of these fans is directly related to the efficient operation of the ACC and the power plant. Accurate testing of the performance characteristics of these large scale fans are thus desired to aid in improving axial flow fan design. The large scale of these axial flow fans, that can be up to 14.63 m (48 ft) [1], is too large to test in conventional fan test facilities. Thus, smaller, geometrically similar scale model fans are tested, and its results scaled to represent that of the full scale prototype fan using the fan scaling laws.

There does however exist some uncertainty with regards to the accuracy of the fan scaling laws when used to predict the performance characteristics of the full scale prototype fan from model testing. This uncertainty stems from the large difference in Reynolds number, based on fan blade chord length, that typically exists between the prototype and model fan. This infers a dissimilar flow regime across the fan blades of the prototype and model fan. A proposed method to improve the Reynolds number similarity between the model and prototype fan is to increase the turbulence intensity of the flow in which the model fan is tested.

The M-fan of Wilkinson [2] is used to investigate this testing method. Increasing the turbulence intensity of the flow across a NASA LS 0413 airfoil, used in the blading of the M-fan, has been shown to delay stall to a higher angle of attack and resulting in higher maximum coefficients of lift, as shown in figure 1, similar to increasing the Reynolds number [3]. The M-fan has been shown to exhibit nearly two dimensional flow across its fan blades, far from the end walls [4], and, assuming the solidity is low enough to consider the fan blades as isolated airfoils, suggests that increasing the turbulence intensity of the flow in which the fan is tested, will yield similar results to that of the NASA LS 0413 tests. This is confirmed by conducting experimental fan tests using the ISO 5801 Type A fan test facility [5] located at Stellenbosch University, with the turbulence in the flow being produced by passive square grids placed upstream of the M-fan.

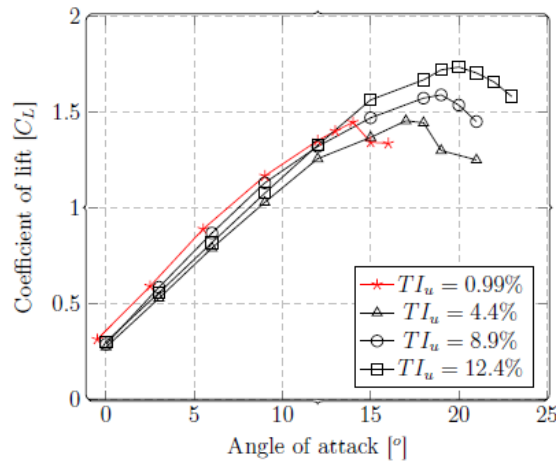

Figure 1: NASA LS 0413 Coefficient of lift at Re = 620 000.

## M-FAN SPECIFICATIONS

The M-fan is designed as a high volume flow rate, low pressure rise fan for use in large air-cooled heat exchangers. The NASA LS 0413 aerofoil of McGhee and Beasley [6] is used in the blading of the M-fan with an optimized camber distribution going from 3.5 % at the hub to 0.8 % at its tip. For this investigation, the scale model M-fan described in Wilkinson *et al.* [7] is used. The specifications of the design and model M-fan is given in table 1 and a schematic of the M-fan is given in figure 2.

Table 1: Fan specification [7].

	Design	Scaled
<b>Diameter</b>	24 ft [7.3152 m]	1.534 m
<b>Flow rate</b>	333 m <sup>3</sup> /s	14.37 m <sup>3</sup> /s
<b>Fan static pressure</b>	116.7 Pa	115.15 Pa
<b>Fan rotational speed</b>	151 RPM	722 RPM
<b>Hub-to-tip-ratio</b>	0.287	0.287
<b>Blade setting angle</b>	34°	34°
<b>Atmospheric pressure</b>	101 325 Pa	101 325 Pa

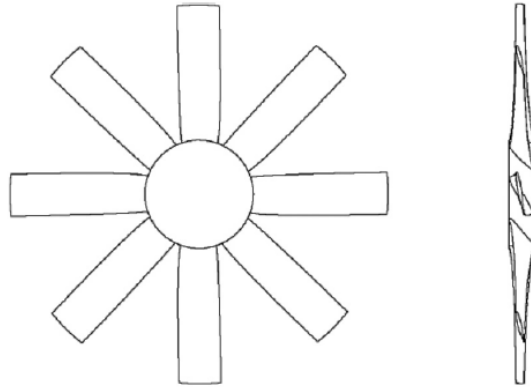

Figure 2: M-fan schematic [7].

## FAN TEST FACILITY

Testing of the M-fan takes place in the ISO 5801 fan test facility located at Stellenbosch University. This facility is classified as a type A (free inlet, free outlet) facility and testing is done in accordance with the BS EN ISO 5801:2018 fan test standards [5]. A schematic of the facility is shown in figure 3. Air is drawn into the facility through the inlet bellmouth (1) after which it passes through the flow louvres (3) used to control the volume flow rate through the facility. An auxiliary fan (5) is used to help overcome the friction and pressure losses at high volume flow rates during testing. The flow passes through flow straighteners at (2), (4), (6) and (7) before entering the settling chamber (8). Within the settling chamber is a set of 3 wire meshes (9) that equally distributes the flow before it passes through the model fan (10) and back into the atmosphere. The model fan is situated within a 1.542 m shroud with a bellmouth inlet and is driven by a 10 kW motor (11).

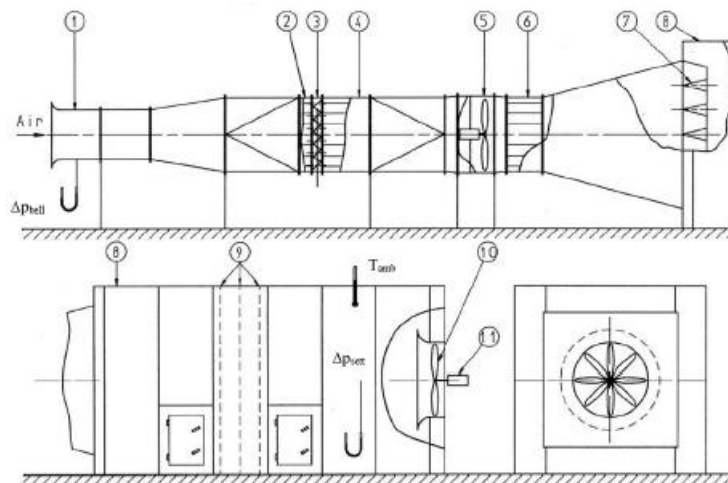

Figure 3: ISO 5801 Type A fan test facility [8].

During a test run, the pressure across the inlet bellmouth ( $\Delta p_{\text{bell}}$ ), the pressure across the fan ( $\Delta p_{\text{sett}}$ ), the fan rotational speed ( $n$ ) and the fan torque ( $T$ ) is measured at different louvres settings. Additionally, the temperature within the settling chamber ( $T_{\text{amb}}$ ) and the atmospheric pressure ( $p_{\text{amb}}$ ) is measured before and after each test and the average value used to calculate the mean air density ( $\rho$ ) during the test. With these measured parameters, the fan static pressure ( $\Delta p_{\text{fs}}$ ), fan static efficiency ( $\eta_{\text{fs}}$ ) and fan power ( $P$ ) curves can be generated.

Modifications to the fan test facility is required to accommodate the passive square grids that will be used to generate the turbulent flow at the inlet of the fan. The purpose of the modification is to increase the distance between the passive grids and the fan to allow for the turbulent flow to

develop fully. An annular pipe section is constructed for this purpose and attached to the outside of the fan test facility as shown in figure 4. An annular pipe section is used to force the inlet flow over the fan blades, effectively maintaining a free inlet free outlet configuration. Using a normal ducted inlet, as shown in figure 5, will not give an accurate representation of the performance of the fan being tested due to the stagnation of the inlet flow at the fan hub.

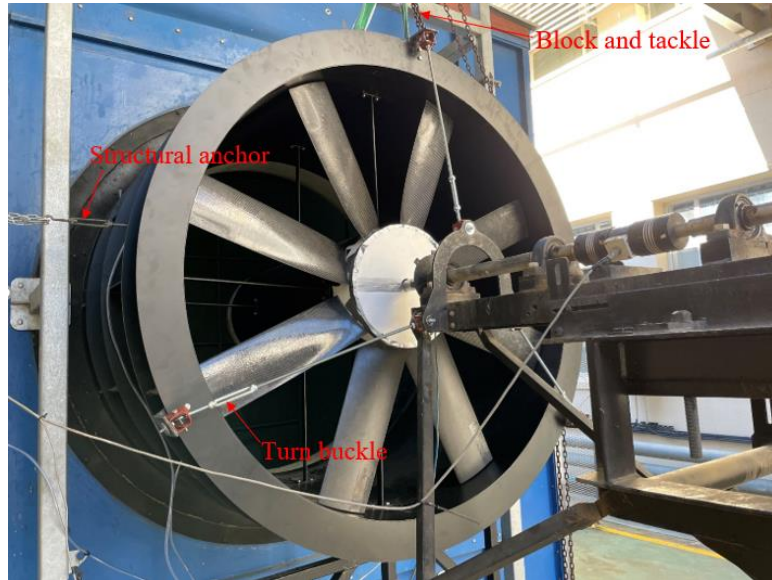

Figure 4: Structural mounting of the annular duct.

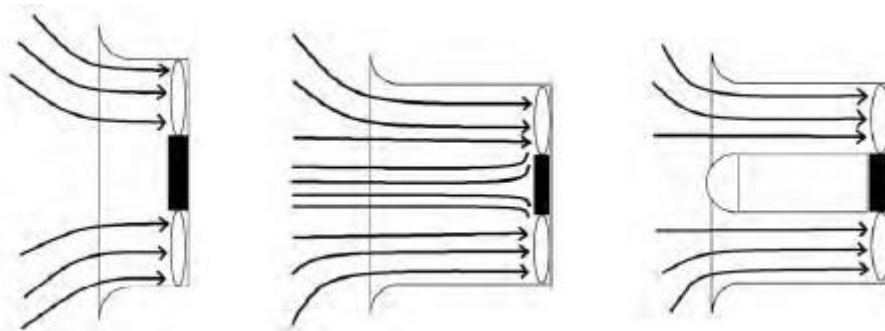

Figure 5: Free inlet (left), ducted inlet (center) and annular inlet (right).

## TURBULENCE PRODUCING GRIDS

The use of passive square mesh grids is a common and effective method to produce nearly isotropic turbulence within a wind tunnel [9]. The choice of square mesh grid for this investigation is based on the recommendations of Roach [9] and Vita *et al.* [10]. Furthermore, rectangular bars are used in the construction of the grids to fix the point of flow separation, thus reducing the variability in the turbulent flow field when testing at different flow velocities. The main dimensions of the passive grids, as shown in figure 6, are given in table 2.

Table 2: Grid dimensions

	Bar width, $b$ [m]	Mesh width, $M$ [m]	Porosity, $\beta$
<b>Grid 1</b>	0.01	0.1	0.81
<b>Grid 2</b>	0.03	0.12	0.5625
<b>Grid 3</b>	0.05	0.2	0.5625

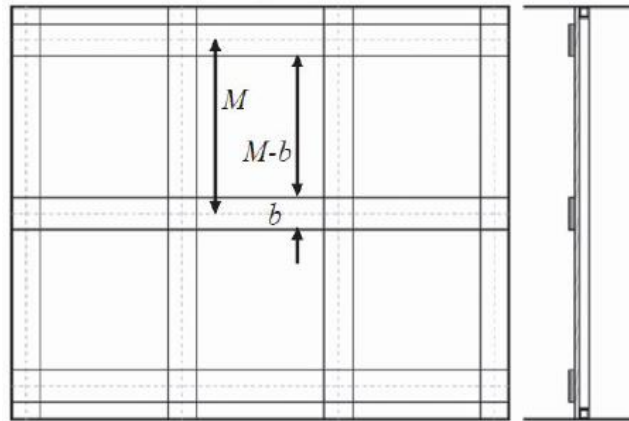

Figure 6: Passive square mesh grid [10].

The grid porosity is defined as:

$$\beta = \left(1 - \frac{b}{M}\right)^2$$

The turbulence produced by the three passive grids is measured using constant temperature anemometry (CTA). A Dantec Dynamics 55R51 X-probe connected to a Dantec Dynamics Multichannel CTA 54N81 is used to measure the turbulence produced by the passive grids. The X-probe allows for the simultaneous measurement of the streamwise- and transverse turbulence components, thus enabling the evaluation of the turbulence isotropy. The grids are attached to the bellmouth upstream of where the model fan will be positioned as shown in figure 7. The X-probe is placed 1.4 m downstream of the grids, where the leading edge of the fan blade will be positioned. Air flow is produced using the fan test facility's auxiliary fan and the flow velocity is sampled at 25 kHz using a constant overheat ratio. The yaw coefficients of the X-probe are kept at the default value of  $k^2 = 0.04$ .

The characteristics of interest are the turbulence intensity (TI), turbulence integral length scale (L) and the Taylor micro scale ( $\lambda$ ). Turbulence intensity is the ratio between the root mean square value of the fluctuating velocity components and the mean flow velocity. The turbulence integral length scale represents the size of largest energy containing eddies while the Taylor micro scale represents the scale of eddies that are largely responsible for dissipation [11]. The detailed calculation of the turbulence characteristics from hot wire measurements and further information relating to hot wire anemometry is further described in detail by Steenkamp [3].

The resulting turbulence characteristics of the flow produced by each grid are given in table 3. The relative uncertainty of the measurements is estimated to be 8.1 % using the method described by Jorgensen [12]. The similarity between the streamwise- ( $TI_u$ ) and transverse turbulence intensity ( $TI_v$ ) gives a good indication that the turbulent flow can be considered isotropic at a distance of 1.4 m downstream of the passive grids. The values for turbulence integral length scales (L) and Taylor micro scale ( $\lambda$ ) are very similar between the three grids and are not expected to have any significant influence on the measured fan performance ([14], [15], [16]).

Table 3: Turbulent flow characteristics

	$TI_u$ [%]	$TI_v$ [%]	$L_u$ [m]	$L_v$ [m]	$\lambda_u$ [m]	$\lambda_v$ [m]
<b>No grid</b>	0.82	1.3	n/a	n/a	n/a	n/a
<b>Grid 1</b>	4.1	3.8	0.047	0.027	0.0049	0.0044
<b>Grid 2</b>	6.4	5.9	0.062	0.029	0.0059	0.0048
<b>Grid 3</b>	9.4	8.6	0.064	0.031	0.0072	0.0052



Figure 7: Grid 1 (top left), Grid 2 (top right) and Grid 3 (bottom).

## RESULTS

The repeatability of the fan tests is firstly determined by conducting 4 fan tests using the M-fan. The low value for standard deviation ( $\sigma$ ) and relative standard deviation (RSD) of the fan performance characteristics given in table 4 indicates that, even with the modification to the fan test facility, the results obtained using this facility is accurate and repeatable.

Table 4: Fan testing repeatability

	$\sigma$	RSD
$\Delta p_{fs}$	1.31 Pa	0.664 %
$\eta_{fs}$	0.458 %	1.30 %
<b>P</b>	28.2 W	0.903 %

The performance characteristics of the M-fan at its design blade setting angle ( $\zeta = 34^\circ$ ), defined as the angle between the blade chord and the tangential velocity vector at the blade root, and a tip clearance of  $c_t = 3$  mm is shown in figure 8, 9 and 10. Increasing the turbulence intensity of the



flow upstream of the M-fan showed to have no effect on the performance characteristics of the fan. This is the expected result as, particularly at the higher volume flow rates, the fan blade angle of attack is low. The flow across the majority of the fan blade at the higher flow rates is also two dimensional [4], allowing for comparisons with the blade sectional airfoil performance characteristics. The results from Steenkamp [3] on the NASA LS 0413 airfoil, used in the balding of the M-fan, showed that increasing the turbulence intensity of the flow at which the airfoil is tested only resulted in a very small decrease in the coefficient of lift at low angles of attack. Increasing the Reynolds number of the NASA LS 0413 airfoil had no effect on the lift coefficient at low angles of attack [3]. With lift being the main contributor to the fan static pressure rise and fan power, little variation in the fan performance with increased turbulence intensity of the flow is expected, at least for the design blade setting angle.

It is however still not clear if increasing the turbulence intensity of the flow in which a fan is tested is similar to increasing the Reynolds number. To evaluate this will require testing the M-fan at a sufficiently high blade setting angle to ensure that the blade angle of attack is operating close to or at the point of stall. It is at these high angles of attack at which the effects of turbulence intensity and Reynolds number should be the most noticeable. The M-fan is thus also tested at a blade setting angle of  $\zeta = 40^\circ$ , the highest blade angle that the fan test facility measuring equipment can accommodate. The performance characteristics of the M-fan at this blade setting angle is given in figure 11, 12 and 13.

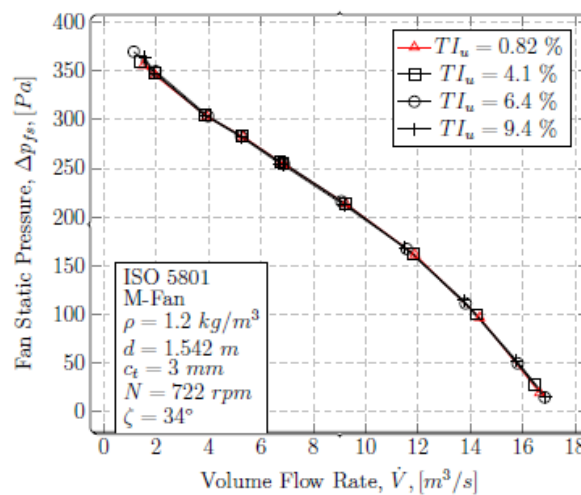

Figure 8: Fan static pressure at various turbulence intensities.

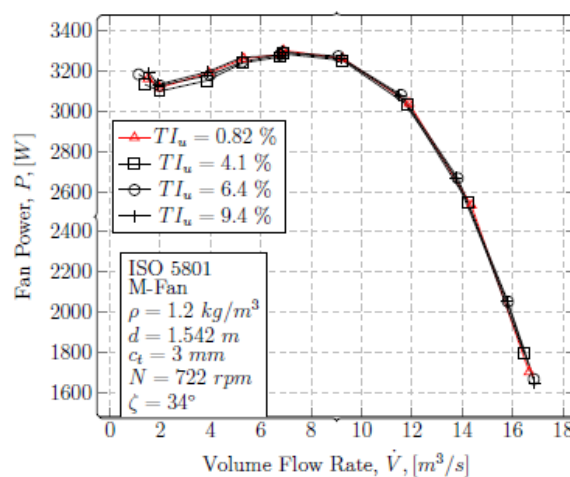

Figure 9: Fan power at various turbulence intensities.

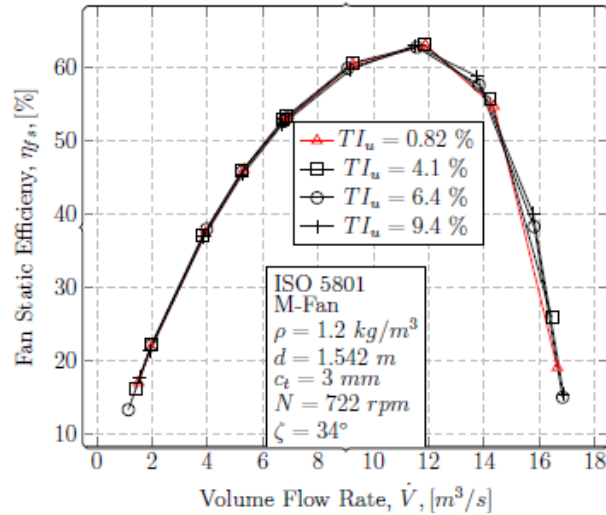

Figure 10: Fan static efficiency at various turbulence intensities.

Increasing the turbulence intensity of the flow when testing the M-fan at  $\zeta = 40^\circ$  does influence the performance characteristics of the M-fan. Focusing on the 12 – 20 m<sup>3</sup>/s volume flow rate range (area highlighted in red), an increase in the fan static pressure and fan power with an increase in the turbulence intensity is noticed. These increases are larger than the standard deviation for repeatability and can thus be attributed to the effect of the turbulence intensity on the performance of the M-fan. This resulted in increasing the fan static efficiency from 56.58 % at  $TI_u = 0.82\%$  to 58.39 % at  $TI_u = 9.4\%$ . This is similar to increasing the Reynolds number of the fan. The validity of increasing the turbulence intensity of the flow to simulate higher Reynolds number operation is thus shown.

At a volume flow rate below 10 m<sup>3</sup>/s, the fan blades are clearly stalled, however, increasing the turbulence intensity of the flow should move the point of stall to a lower volume flow rate. This is not evident from the results. Louw [17] noted that the flow across fan blades tends to become three dimensional, due to a radial velocity component, as the volume flow rate decreases. This would suggest that the comparison of the M-fan performance characteristics to that of the NASA LS 0413 airfoil is no longer valid.

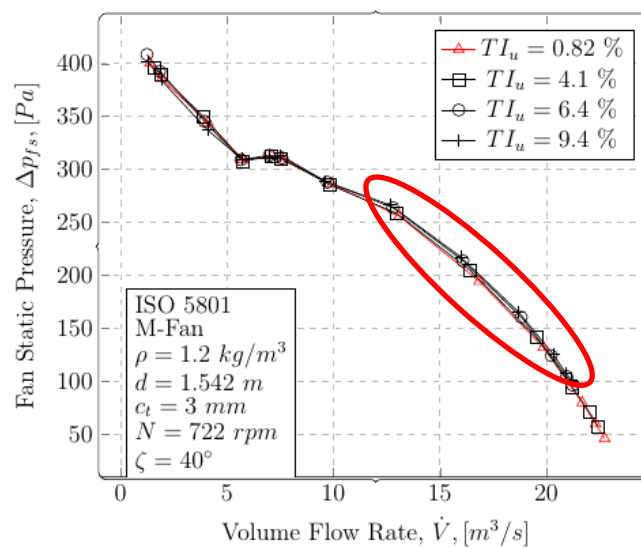

Figure 11: Fan static pressure at various turbulence intensities.



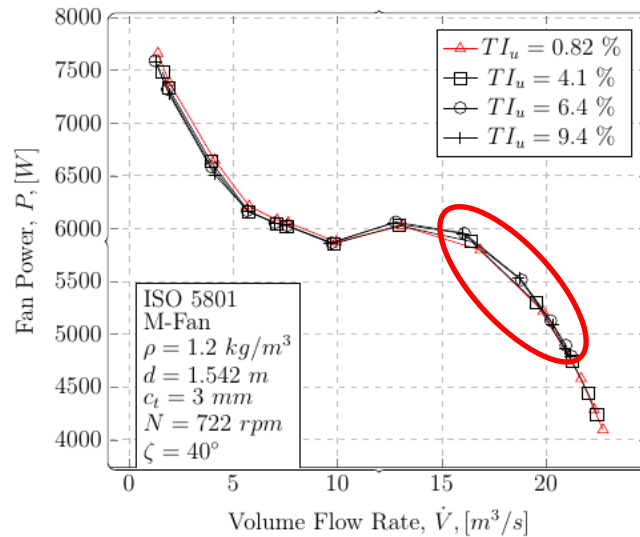

Figure 12: Fan power at various turbulence intensities.

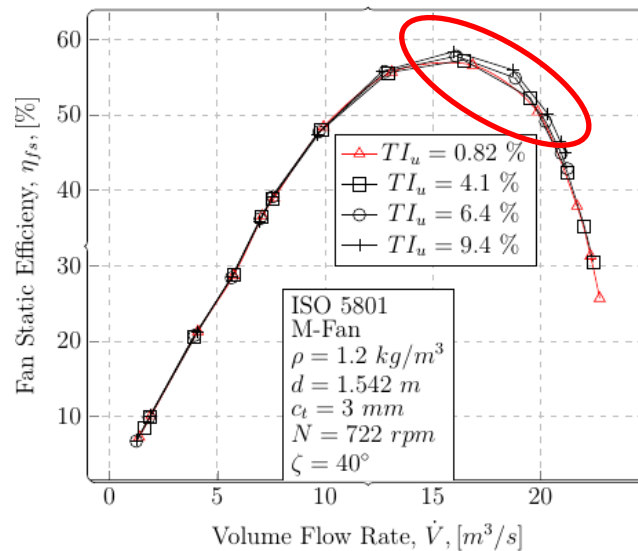

Figure 13: Fan static efficiency at various turbulence intensities.

## CONCLUSION

The validity of increasing the turbulence intensity of the flow in which a fan is tested to simulate higher Reynolds number operation is investigated in this paper. Experimental evidence from testing the M-fan at a sufficiently high blade setting angle indicates that this is indeed true, however, only if the flow across the fan blades is considered to be two dimensional.

The M-fan, tested at its design blade setting angle ( $\zeta = 34^\circ$ ), is shown to be independent of turbulence intensity in the flow and thus also by extension, independent from any Reynolds number effects. It can thus be concluded that at the scale tested in the ISO 5801 fan test facility, using the fan scaling laws on the M-fan to obtain performance characteristic data representing that of a larger scale M-fan will yield accurate results.

## BIBLIOGRAPHY

- [1] O. P. H. Augustyn, *Experimental and numerical analysis of axial flow fans*, Stellenbosch University, **2013**.
- [2] M. B. Wilkinson, *The design of a large diameter axial flow fan for air-cooled heat exchanger applications*, Stellenbosch University, **2017**.
- [3] G. M. Steenkamp, *Reynolds Number Scaling of Axial Flow Fans*, Stellenbosch University, **2021**.
- [4] J. N. Rohwer, *Blade surface pressure measurements of an axial flow fan*, Stellenbosch University, **2019**.
- [5] BSI, *BS EN ISO 5801:2017 - Fans - Performance testing using standardized airways*. British Standards Institute, **2017**.
- [6] R. J. McGhee and W. D. Beasley, *Low-Speed Wind-Tunnel Results for a Modified 13-Percent-Thick Airfoil*, Langley research center, Hampton, Virginia, USA, **1975**.
- [7] M. B. Wilkinson, S. J. Van Der Spuy, and T. W. Von Backström, *Performance Testing of an Axial Flow Fan Designed for Air-Cooled Heat Exchanger Applications*, *J. Eng. Gas Turbines Power*, vol. 141, no. 5, pp. 1–9, **2019**, doi: 10.1115/1.4041010.
- [8] D. G. Kröger, *Air-cooled Heat exchangers and Cooling Towers: Thermal-Flow Performance Evaluation and Design:VI*, vol. 1. **2004**.
- [9] P. E. Roach, *The generation of nearly isotropic turbulence by means of grids*, *Int. J. Heat Fluid Flow*, vol. 8, no. 2, pp. 82–92, **1987**, doi: 10.1016/0142-727X(87)90001-4.
- [10] G. Vita, H. Hemida, T. Andrianne, and C. C. Baniotopoulos, *Generating atmospheric turbulence using passive grids in an expansion test section of a wind tunnel*, *J. Wind Eng. Ind. Aerodyn.*, vol. 178, no. August 2017, pp. 91–104, **2018**, doi: 10.1016/j.jweia.2018.02.007.
- [11] P. W. Bearman and T. Morel, *Effect of free stream turbulence on the flow around bluff bodies*, *Prog. Aerosp. Sci.*, vol. 20, no. 2–3, pp. 97–123, **1983**, doi: 10.1016/0376-0421(83)90002-7.
- [12] F. E. Jorgensen, *How to measure turbulence with hot-wire anemometers - a practical guide*, Dantec Dynamics, **2002**.
- [13] A. M. Fisher, *The Effect of Freestream Turbulence on Fixed and Flapping Micro Air Vehicle Wings*, RMIT University, **2013**.
- [14] K. E. Swalwell, *The effect of turbulence on stall of horizontal axis wind turbines*, Monash University, **2005**.
- [15] S. Shahinfar and J. H. M. Fransson, *Effect of free-stream turbulence characteristics on boundary layer transition*, *J. Phys. Conf. Ser.*, vol. 318, **2011**, doi: 10.1088/1742-6596/318/3/032019.
- [16] J. Grzelak and Z. Wierciński, *Length scale of free stream turbulence and its impact on bypass transition in a boundary layer*, *J. Appl. Fluid Mech.*, vol. 10, no. 2, pp. 713–724, **2017**, doi: 10.18869/acadpub.jafm.73.239.27159.
- [17] F. G. Louw, *Investigation of the flow field in the vicinity of an axial flow fan during low flow rates*, Stellenbosch University, **2015**.